



Dual N-Channel Enhancement Mode Field Effect Transistor

| PRODUCT SUMMARY | | |
|------------------|----------------|------------------------------|
| V _{DSS} | I _D | R _{DS(ON)} (mΩ) Max |
| 30V | 4.5A | 42 @ V _{GS} =10V |
| | | 74 @ V _{GS} =4.5V |

FEATURES

- Super high dense cell design for low R_{DS(ON)}.
- Rugged and reliable.
- Surface Mount Package.



ABSOLUTE MAXIMUM RATINGS (T_A=25°C unless otherwise noted)

| Symbol | Parameter | Limit | Units |
|-----------------------------------|--|----------------------|-------|
| V _{DS} | Drain-Source Voltage | 30 | V |
| V _{GS} | Gate-Source Voltage | ±20 | V |
| I _D | Drain Current-Continuous ^a | T _A =25°C | 4.5 |
| | | T _A =70°C | 3.6 |
| I _{DM} | -Pulsed ^b | 30 | A |
| E _{AS} | Single Pulse Avalanche Energy ^d | 16 | mJ |
| P _D | Maximum Power Dissipation ^a | T _A =25°C | 1.47 |
| | | T _A =70°C | 0.94 |
| T _J , T _{STG} | Operating Junction and Storage Temperature Range | -55 to 150 | °C |

THERMAL CHARACTERISTICS

| | | | |
|------------------|---|----|------|
| R _{θJA} | Thermal Resistance, Junction-to-Ambient | 85 | °C/W |
|------------------|---|----|------|

SP3900

Ver 1.1

ELECTRICAL CHARACTERISTICS (T_A=25°C unless otherwise noted)

| Symbol | Parameter | Conditions | Min | Typ | Max | Units |
|---|----------------------------------|--|-----|-----|------|-------|
| OFF CHARACTERISTICS | | | | | | |
| BV _{DSS} | Drain-Source Breakdown Voltage | V _{GS} =0V, I _D =250uA | 30 | | | V |
| I _{DSS} | Zero Gate Voltage Drain Current | V _{DS} =24V, V _{GS} =0V | | | 1 | uA |
| I _{GSS} | Gate-Body Leakage Current | V _{GS} = ±20V, V _{DS} =0V | | | ±100 | nA |
| ON CHARACTERISTICS | | | | | | |
| V _{GS(th)} | Gate Threshold Voltage | V _{DS} =V _{GS} , I _D =250uA | 1 | 2.1 | 3 | V |
| R _{DS(ON)} | Drain-Source On-State Resistance | V _{GS} =10V, I _D =2.25A | | 34 | 42 | m ohm |
| | | V _{GS} =4.5V, I _D =1.7A | | 55 | 74 | m ohm |
| g _{FS} | Forward Transconductance | V _{DS} =10V, I _D =2.25A | | 9 | | S |
| DYNAMIC CHARACTERISTICS ^c | | | | | | |
| C _{ISS} | Input Capacitance | V _{DS} =10V, V _{GS} =0V f=1.0MHz | | 380 | | pF |
| C _{OSS} | Output Capacitance | | | 63 | | pF |
| C _{RSS} | Reverse Transfer Capacitance | | | 46 | | pF |
| SWITCHING CHARACTERISTICS ^c | | | | | | |
| t _{D(ON)} | Turn-On Delay Time | V _{DD} =15V I _D =1A V _{GS} =10V R _{GEN} = 6 ohm | | 11 | | ns |
| t _r | Rise Time | | | 11 | | ns |
| t _{D(OFF)} | Turn-Off Delay Time | | | 17 | | ns |
| t _f | Fall Time | | | 4.6 | | ns |
| Q _g | Total Gate Charge | V _{DS} =15V, I _D =2.25A, V _{GS} =10V | | 6 | | nC |
| | | V _{DS} =15V, I _D =2.25, V _{GS} =4.5V | | 3.2 | | nC |
| Q _{gs} | Gate-Source Charge | V _{DS} =15V, I _D =2.25A, V _{GS} =10V | | 1.2 | | nC |
| Q _{gd} | Gate-Drain Charge | | | 1.7 | | nC |
| DRAIN-SOURCE DIODE CHARACTERISTICS AND MAXIMUM RATINGS | | | | | | |
| V _{SD} | Diode Forward Voltage | V _{GS} =0V, I _S =1A | | 0.8 | 1.2 | V |

Notes

- Surface Mounted on FR4 Board, t ≤ 10sec.
- Pulse Test: Pulse Width < 300us, Duty Cycle < 2%.
- Guaranteed by design, not subject to production testing.
- Starting T_J=25°C, L=0.5mH, V_{DD} = 20V. (See Figure13)

Jan,23,2014

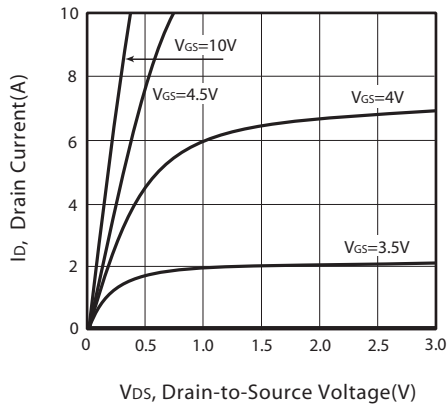

Figure 1. Output Characteristics

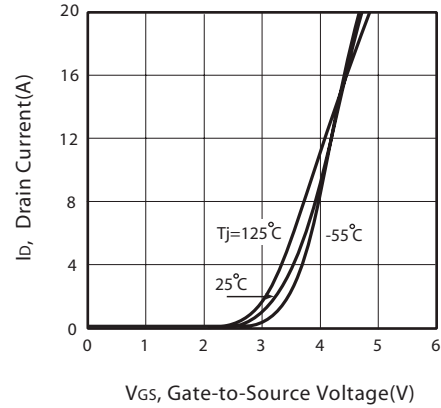

Figure 2. Transfer Characteristics

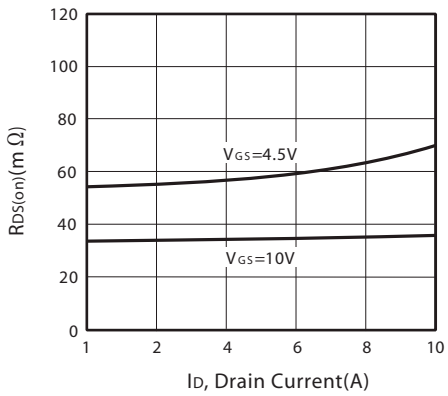

Figure 3. On-Resistance vs. Drain Current and Gate Voltage

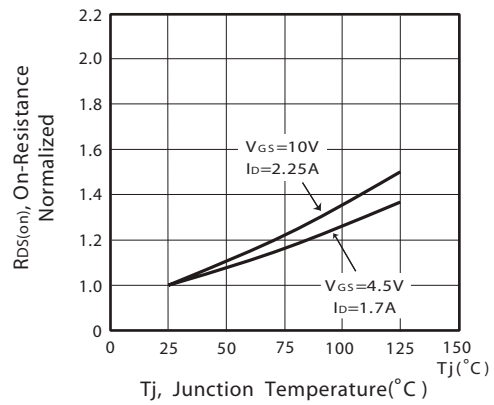

Figure 4. On-Resistance Variation with Drain Current and Temperature

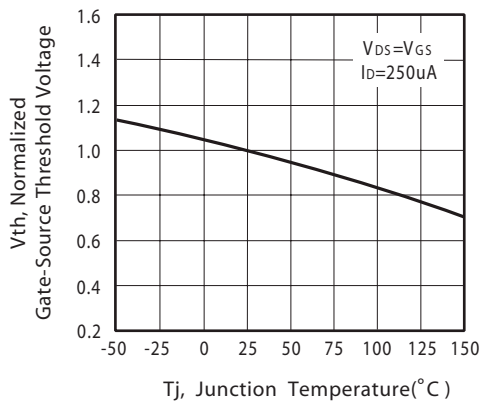

Figure 5. Gate Threshold Variation with Temperature

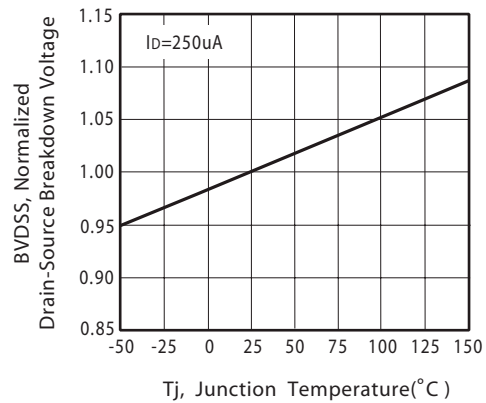

Figure 6. Breakdown Voltage Variation with Temperature

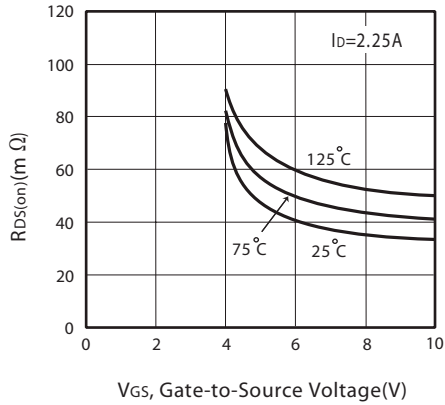

Figure 7. On-Resistance vs. Gate-Source Voltage

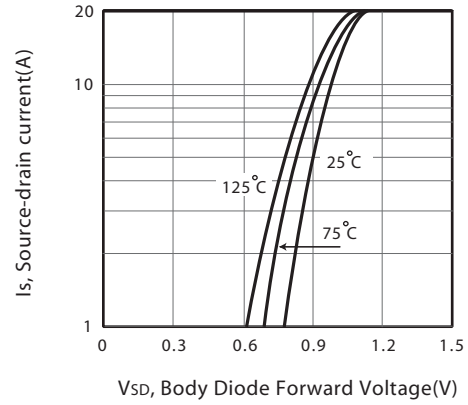

Figure 8. Body Diode Forward Voltage Variation with Source Current

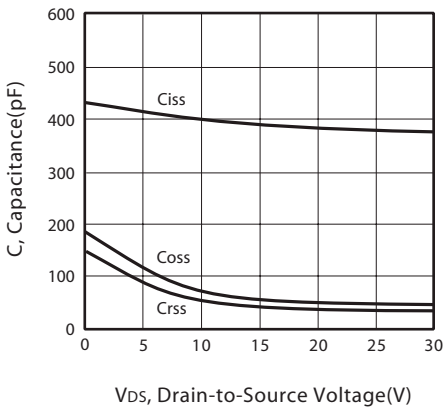

Figure 9. Capacitance

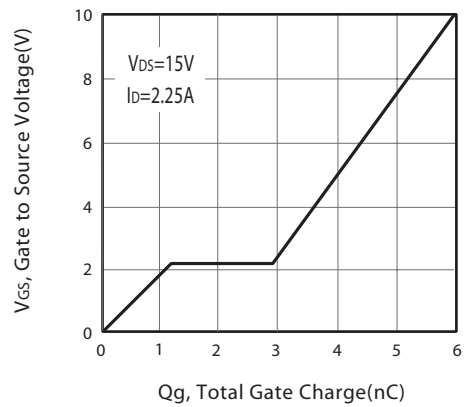

Figure 10. Gate Charge

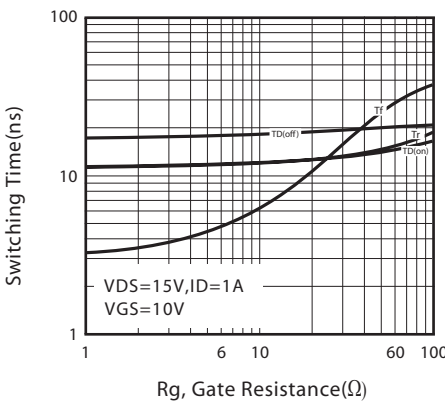

Figure 11. switching characteristics

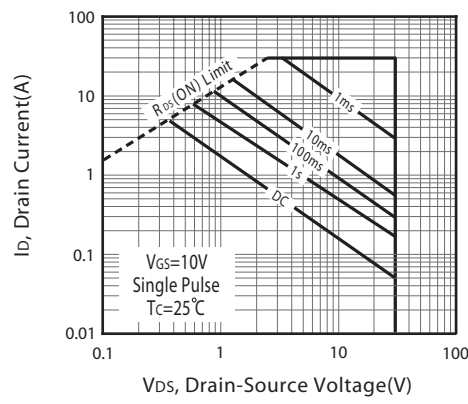
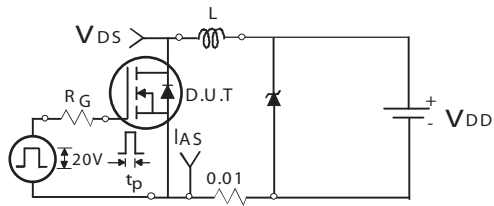
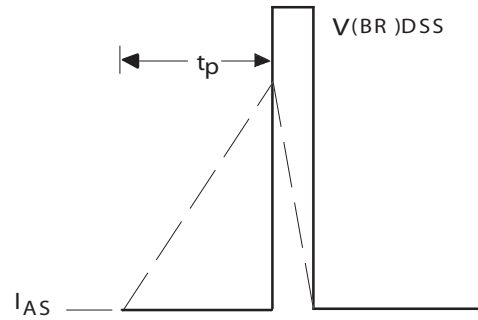

Figure 12. Maximum Safe Operating Area



Unclamped Inductive Test Circuit

Figure 13a.



Unclamped Inductive Waveforms

Figure 13b.

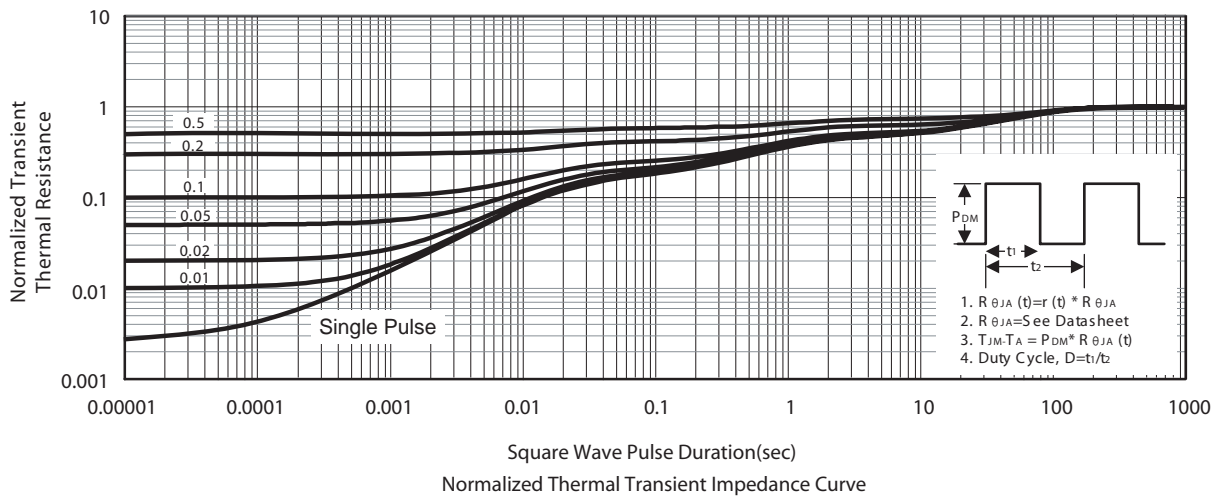

PACKAGE OUTLINE DIMENSIONS

DFN 3x3-8L

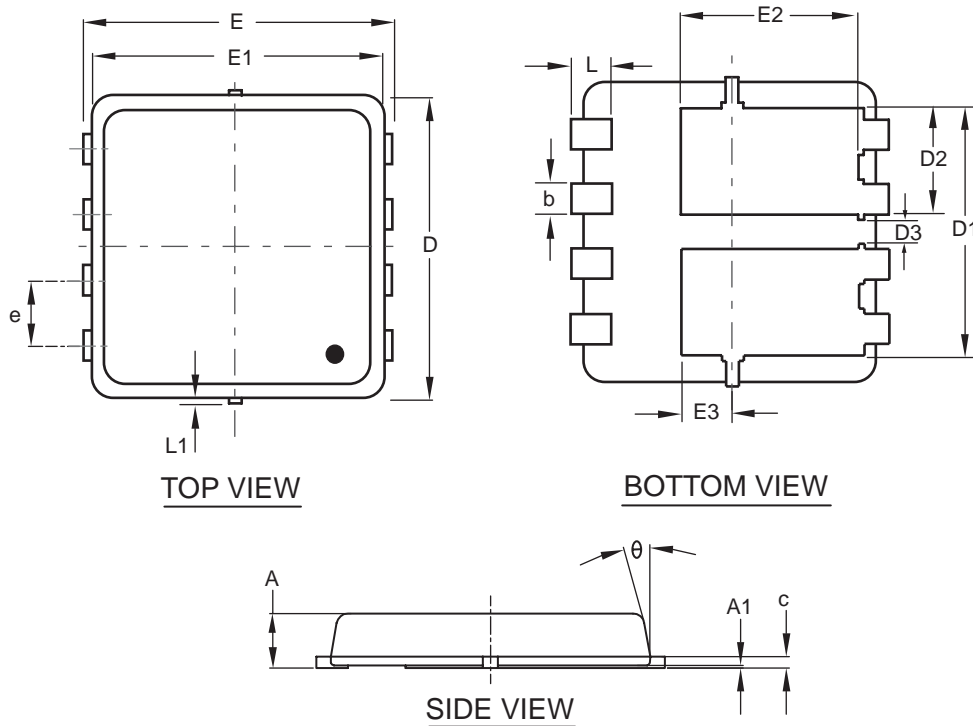

| SYMBOLS | MILLIMETERS | | |
|----------|-------------|-------|-------|
| | MIN | NOM | MAX |
| A | 0.70 | 0.80 | 0.90 |
| A1 | 0.00 | — | 0.05 |
| b | 0.24 | 0.30 | 0.35 |
| c | 0.10 | 0.152 | 0.25 |
| D | 3.00 BSC | | |
| D1 | 2.475 BSC | | |
| D2 | 1.063 BSC | | |
| D3 | 0.225 BSC | | |
| E | 3.20 BSC | | |
| E1 | 3.00 BSC | | |
| E2 | 1.813 BSC | | |
| E3 | 0.525 BSC | | |
| e | 0.65 BSC | | |
| L | 0.30 | 0.40 | 0.50 |
| L1 | 0.00 | — | 0.100 |
| θ | 0° | 10° | 12° |

TOP MARKING DEFINITION

